



9292 Jeronimo Road
Irvine, CA 92618-1905



Quick Installation Guide

V200 INPUT MONITOR INTERFACE

PROPRIETARY INFORMATION. This document contains proprietary information which may not be duplicated, published or disclosed to others, or used for any purpose without written permission from HID Corporation. 2004 © HID Corporation. All rights reserved.

Document Version 1.1
January 23, 2006
Document Number 6080-908A.2

Contents

Introduction	3
Parts List	3
Product Specifications.....	3
Cable Specifications.....	3
Overview	4
Step 1 Preparations	4
1.1 What you need before getting started	4
1.2 V200	4
Step 2 Hardware Installation	5
2.1 Mounting Instructions	5
2.2 Wiring VertX	5
Contact Information	8

Introduction

VertX™ CS is the first family of access controllers designed specifically for alarm dealers for direct connection to central stations. Because it was designed with central station in mind, VertX CS works with software from leading central station automation providers, including Bold Technologies, DICE and GE MAS.

The V200 is designed to be controlled by a VertX V1000 Access Controller that will also manage communications with the central station automated software. The V200 Input Monitor Interface panel monitors as many as 16 input points.

Parts List

Parts List (included)	Quantity
VertX™ V200 Input Monitor Interface Note: The V200 panel has a plastic base and is covered with a Plastic or Mylar cover.	1
Mounting screws	4
2.2K EOL resistors	4
Quick Installation Guide	1
Installation Wiring Diagram Example	1

Note: A VertX V1000 Access Controller is required.

Product Specifications

Description	Specification
Power Supply	12-16VDC
Maximum current at 12VDC per V200	1 Amp
Average operating current at 12VDC	60mA
Operating temperature range	32°-122°F (0°-50°C)
Humidity	5% to 95% non-condensing

Cable Specifications

Cable Type	Length	Specification
RS-485 *	4000 feet (1220 m) to V1000	Belden 3105A, 22AWG twisted pair, shielded 100Ω cable, or equivalent.
Input Circuits *	500 feet (150 m)	2-conductor, shielded, using ALPHA 1292C (22AWG) or Alpha 2421C (18AWG), or equivalent.
Output Circuits *	500 feet (150 m)	2-conductor, using ALPHA 1172C (22AWG) or Alpha 1897C (18AWG), or equivalent.
Power Supply +12 VDC IN	----	Refer to your Power Supply Installation Guide.

* Minimum wire gauge depends on cable length and current requirements.

Overview

The following outlines what is required to install the V200 Input Monitor Interface panel.

1 Preparations



Preparations include reading through this document.



2 Hardware Installation

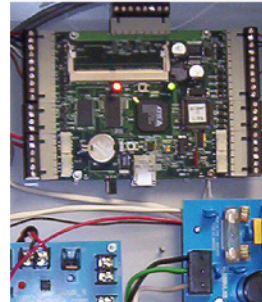

Hardware Installation includes mounting and wiring the interface panel(s).

Step 1 Preparations

1.1 What you need before getting started

Prior to starting the installation, please completely read through this guide.

CAUTION: The V200 is sensitive to Electrostatic Discharges (ESD). Observe precautions while handling the circuit board assembly by using proper grounding straps and handling precautions at all times.

1.2 V200

1. If the V200 will be attached to the end of the RS-485 bus, install a terminating jumper on the termination resistor pins P8 on the cover (P10 on the PCB) of the V200.
2. If the V200 is being installed as part of an array, or in a third party enclosure, follow the directions provided by the Integrator or Dealer.

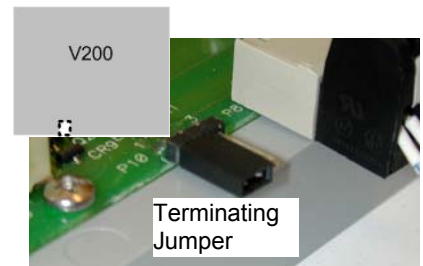

Step 2 Hardware Installation

2.1 Mounting Instructions

1. The V200 should always be mounted in a secure area.
2. Mount the V200 using the four mounting screws (provided) or other appropriate fasteners. Place the fasteners in the corner holes of the base.
3. The V200 panel can be stacked with or without the cover. Do not remove the plastic base. Make sure to position in such a way as to provide room for wiring, air-flow and cable runs.

2.2 Wiring VertX

CAUTION: Connectors on the V200 sides are positioned to be mirror images and are not interchangeable once the installation is complete. Therefore, you cannot unplug the connector from one side of the board and plug it into the corresponding connector on the other side.

1. **Power and Alarm input connections:** Connect power by providing 12VDC to the **P7** connector. +12VDC goes to **Pin 1** and Ground on **Pin 2**. The Bat Fail, AC Fail, and Tamper switch inputs are wired as shown in the table. Connect the Bat Fail and AC Fail inputs to battery low/failure and AC failure contacts provided on the power supply. Connect the Tamper input to a tamper switch on the enclosure.

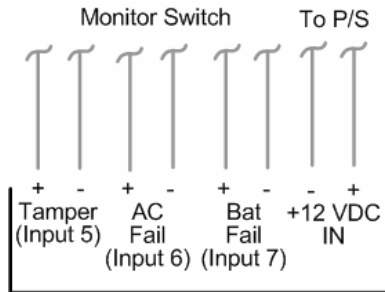

Pin #	P7
1	+12VDC
2	Ground
3	Bat Fail -
4	Bat Fail +
5	AC Fail -
6	AC Fail +
7	Tamper -
8	Tamper +

P7

2. **RS-485 Connections:** Connect the V200 panel to the V1000 controller through the RS-485 cable. See the V1000 Quick Install Guide for further information.

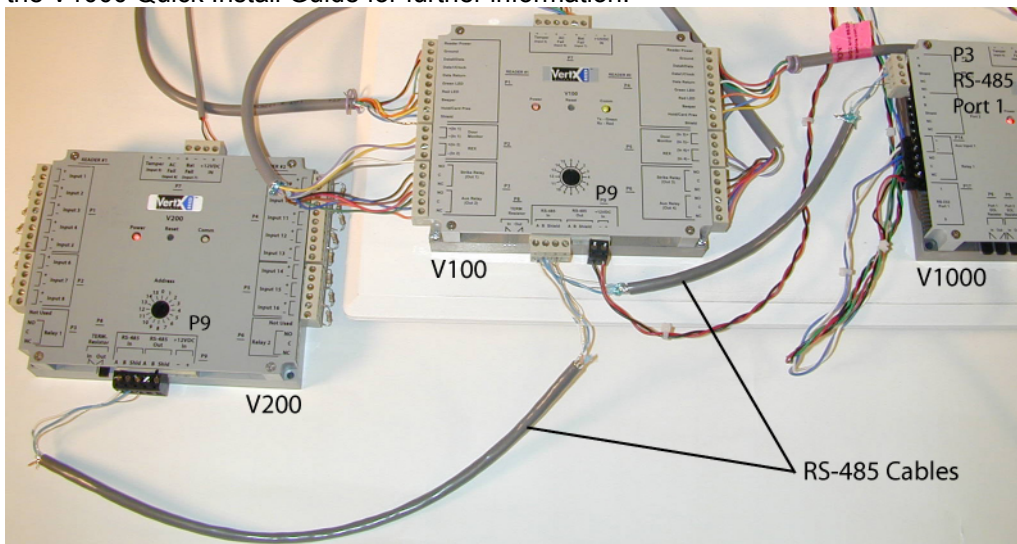

CAUTION: The V1000 RS-485 Ports 1 & 2 (P1) are a common bus and therefore cannot have duplicate Interface Addresses assigned. The same is true of the V1000 RS-485, Ports 3 & 4 (P4). For example, Interface Address 0 (factory default) cannot be assigned to both Ports 1 & 2 (P1).

- Interface Address** – Set the interface address by turning the **Address** dial. Ensure that the V200 Interface Address is documented in the Hardware Installation Worksheet (found in the back of the HID VertX V1000 Quick Install guide).



- Output Connections** – All Output connections are used for general purpose controls. The following table shows where the various outputs are located. Pin numbers shown use the convention “NO/C/NC”.
For example, Output 1, V2000: P3 Pin1 is NO (Normally open) and Pin 2 is C (Common) and Pin 3 is NC (Normally closed).

Note: Relay contacts are rated for 2Amps @ 30VDC.

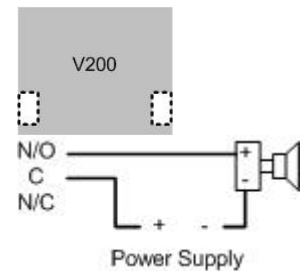

Output number	V2000	V1000	V100	V200	V300
1	P3 Pins 1/2/3 Strike (lock) Relay 1	P14 Pins 2/3/4	P3 Pins 1/2/3 Strike (lock) Relay 1	P3 Pins 2/3/4	P1 Pins 1/2/3
2	P3 Pins 4/5/6 Aux Relay 1	P11 Pins 6/5/4	P3 Pins 4/5/6 Aux Relay 1	P6 Pins 3/2/1	P1 Pins 4/5/6
3	P6 Pins 6/5/4 Strike (lock) Relay 2		P6 Pins 6/5/4 Strike (lock) Relay 2		P1 Pins 7/8/9
4	P6 Pins 3/2/1 Aux Relay 2		P6 Pins 3/2/1 Aux Relay 2		P2 Pins 1/2/3
5					P2 Pins 4/5/6
6					P2 Pins 7/8/9
7					P4 Pins 9/8/7
8					P4 Pins 6/5/4
9					P4 Pins 3/2/1
10					P5 Pins 9/8/7
11					P5 Pins 6/5/4
12					P5 Pins 3/2/1

- Input Connections** – Input connections are used for a combination of specific functions such as Request-to-Exit (REX), door monitor, etc. They can also be used for general purpose monitoring. Connect one side of the switch or contact to the + (plus) lead and the other to the – (minus) lead. The following table shows where the inputs are located. Pin numbers shown on the cover use the convention +/-.

All V200 input points are defaulted for NO switches and are unsupervised (no EOL resistors).

Any input can be configured as a supervised input. They can be configured for resistor values of 1K – 6K Ohm. The setup of supervised inputs should be done during configuration of the VertX units via the

central station automation software (host) or using the Calibrate Input tool explained in the HID VertX V1000 Quick Installation guide.

Example: Input 1, V1000 is: P14 Pin1 is + and Pin 2 is -.

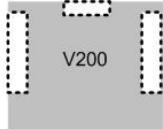

The default input will be all:

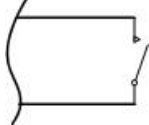

Supervised inputs can be configured for:

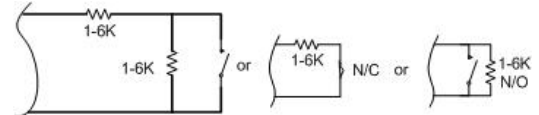

Input number	V2000	V1000	V100	V200	V300
1	P2 Pins 1/2 Door Monitor	P14 Pins 1/2	P2 Pins 1/2 Door Monitor	P1 Pins 1/2	P6 Pins 2/1
2	P2 Pins 3/4 REX Input	P11 Pins 4/3	P2 Pins 3/4 REX Input	P1 Pins 3/4	P3 Pins 1/2
3	P5 Pins 4/3 Door Monitor	P7 Pins 8/7 Tamper	P5 Pins 4/3 Door Monitor	P1 Pins 5/6	P7 Pins 8/7 Tamper
4	P5 Pins 2/1 REX Input	P7 Pins 6/5 AC Fail	P5 Pins 2/1 REX Input	P1 Pins 7/8	P7 Pins 6/5 AC Fail
5	P7 Pins 8/7 Tamper	P7 Pins 4/3 Batt Fail	P7 Pins 8/7 Tamper	P1 Pins 9/10	P7 Pins 4/3 Batt Fail
6	P7 Pins 6/5 AC Fail		P7 Pins 6/5 AC Fail	P2 Pins 1/2	
7	P7 Pins 4/3 Batt Fail		P7 Pins 4/3 Batt Fail	P2 Pins 3/4	
8				P2 Pins 5/6	
9				P4 Pins 10/9	
10				P4 Pins 8/7	
11				P4 Pins 6/5	
12				P4 Pins 4/3	
13				P4 Pins 2/1	
14				P5 Pins 6/5	
15				P5 Pins 4/3	
16				P5 Pins 2/1	
17				P7 Pins 8/7 Tamper	
18				P7 Pins 6/5 AC Fail	
19				P7 Pins 4/3 Batt Fail	

Contact Information

HID Corporation	929274 Jeronimo Road, Irvine, CA 92618-1905
Web Site	http://www.hidcorp.com
Main Phone	(949) 598-1600
Fax	(949) 598-1698
Sales	(800) 210-4744
Technical Support	(800) 237-7769

All National and local Electrical codes apply.

- This equipment is intended to be powered from a limited power source output of a previously certified power supply.
- Changes or modifications not expressly approved by the party responsible for compliance could void the user's authority to operate the equipment.

Class A Digital Devices

FCC Compliance Statement: This equipment has been tested and found to comply with the limits for a Class A digital device, pursuant to part 15 of the FCC Rules. These limits are designed to provide reasonable protection against harmful interference when the equipment is operated in a commercial environment. This equipment generates, uses, and can radiate radio frequency energy and, if not installed and used in accordance with the instruction manual, may cause harmful interference to radio communications. Operation of this equipment in a residential area is likely to cause harmful interference in which case the user will be required to correct the interference at his own expense.

Class B Digital Devices

FCC Compliance Statement: This equipment has been tested and found to comply with the limits for a Class B digital device, pursuant to the limits for a Class B digital device, pursuant to part 15 of the FCC Rules. These limits are designed to provide reasonable protection against harmful interference in a residential installation. This equipment generates, uses, and can radiate radio frequency energy and, if not installed and used in accordance with the instructions, may cause harmful interference to radio communications. However, there is no guarantee that interference will not occur in a particular installation. If this equipment does cause harmful interference to radio or television reception, which can be determined by turning the equipment off and on, the user is encouraged to try to correct the interference by one or more of the following measures:

- Reorient or relocate the receiving antenna.
- Increase the separation between the equipment and the receiver.
- Connect the equipment into an outlet on a circuit different from that to which the receiver is connected.
- Consult the dealer or an experienced radio/TV technician for help.