



9292 Jeronimo Road
Irvine, CA 92618-1905



Quick Installation Guide

V1000 ACCESS CONTROLLER

© 2006 HID Global Corporation. All rights reserved.

Document Version 1.4

October 5, 2006

Document Number 6080-904B.5



Contents

- QUICK START, VERTX (CS) V1000 1**
 - Introduction 3
 - Parts List 3
 - Product Specifications 3
 - Cable Specifications 3

- Overview 4**

- Step 1 Connect..... 5**
 - 1.1 What you need before getting started 5
 - 1.2 V1000..... 5
 - 1.3 Mounting Instructions..... 5
 - 1.4 Wiring VertX..... 5
 - 1.5 Modem 10

- Step 2 Contact..... 11**
 - 2.1 Discovery Client..... 11
 - 2.2 Virtual Port 12

- Step 3 Configure 12**
 - 3.1 VertX Communications 12

- Step 4 Communicate 14**

- Appendices 14**
 - Trouble-shooting 14
 - Firewall 16
 - Central Station Automation Providers..... 16

- Contact Information..... 17**

- Configuration Checklist - Static and Modem 19**

- Installation Worksheet.....A1**

Introduction

VertX™ CS is the first family of access controllers designed specifically for alarm dealers for direct connection to central stations. Because it was designed with the central station in mind, VertX CS works with software from leading central station automation providers, including Bold Technologies, DICE, Micro Key, and Patriot Systems.

The V1000 is designed to control readers, door contact inputs and relays through the RS-485 loop and any combination of up to 32 Interface Panels (V100 Door/Reader Interface, V200 Input Monitor Interface and/or V300 Output Control Interface). In addition, the V1000 Access Controller manages communications with the central station automated software.

Parts List

Description	Quantity
VertX™ V1000 Access Controller Note: The V1000 controller has a plastic base and is covered with a Plastic or Mylar cover.	1
- Lithium Battery	1
- Mounting screws	4
- 2.2K EOL resistors	8
- HID Serial Adapter cable (P/N 70007)	1
- Quick Installation Guide	1
- Installation Wiring Diagram Example	1

Note: One or more VertX Interface panels are required.

Note: A modem and RS-232 Serial cable must be purchased separately if your installation includes a modem.

Product Specifications

Description	Specification
Power Supply	12-16VDC
Maximum current at 12VDC per V1000	1 Amp
Average operating current at 12VDC	210mA
Operating temperature range	32°-122°F (0°-50°C)
Humidity	5% to 95% non-condensing

Cable Specifications

Cable Type	Length	Specification
RS-485 *	4000 feet (1220 m) to host	Use Belden 3105A, 22AWG twisted pair, shielded 100Ω cable, or equivalent.
RS-232	15 feet (4.57 m) for RS232 Serial modem cable 6 inch (15.24 cm) adapter	Use any RS232 Serial modem cable specified by the modem manufacturer. HID Serial Adapter cable, P/N 70007.
Input Circuits *	500 feet (150 m)	2-conductor, shielded, using ALPHA 1292C (22AWG) or Alpha 2421C (18AWG), or equivalent.
Output Circuits *	500 feet (150 m)	2-conductor, using ALPHA 1172C (22AWG) or Alpha 1897C (18AWG), or equivalent.

Cable Type	Length	Specification
Ethernet	328 feet (100 m)	Cat5, Cat5E, and Cat6
Power Supply +12 VDC IN	----	Refer to your Power Supply Installation Guide.

* Minimum wire gauge depends on cable length and current requirements.

Overview

The following outlines what is required to install the V1000.

1

Connect

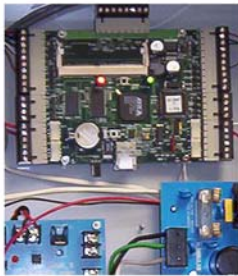

Connect includes:
Mounting and wiring the controller and interface panels.

2

Contact

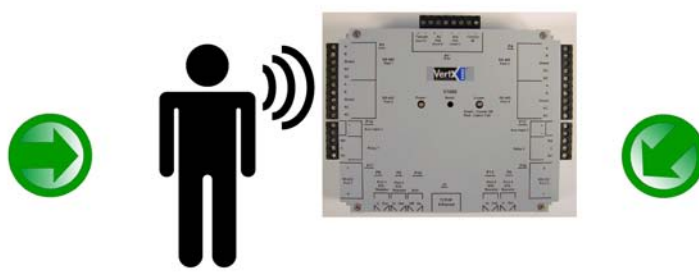

Contact includes:
Establishing communication with the VertX controller.

3

Configure



Configure includes:
Establishing communication so the central station automation software can push down the detailed configuration data.

4

Communicate



Communicate includes:
VertX communicating with the central station to complete the configuration process.

Step 1 Connect

1.1 What you need before getting started

Prior to starting the installation, please completely read this guide.

CAUTION: The V1000 is sensitive to Electrostatic Discharges (ESD). Observe precautions while handling the circuit board assembly by using proper grounding straps and handling precautions at all times.

1.2 V1000

1. Verify the battery jumper is installed in the **ON** position (or **OUT** position on old covers), P15 connector (V1000).
2. Verify that the V1000 termination jumper is in the **Out** position when there are no panels attached to the port. If there are downstream interface panels attached then the termination jumper should be in the **In** position. The V1000 is shipped with jumpers in the **Out** positions.

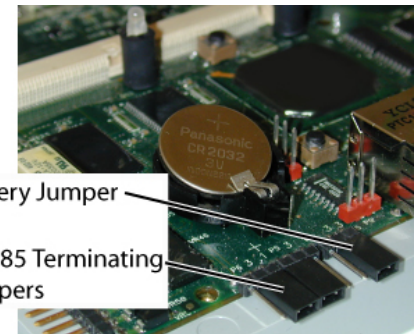
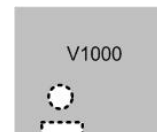

1.3 Mounting Instructions

1. The V1000 should always be mounted in a secure area.
2. Mount the V1000 using the four mounting screws (provided) or other appropriate fasteners. Place the fasteners in the corner holes of the base.
3. The V1000 can be stacked with or without the cover. Do not remove the plastic base. Make sure you position the V1000 in such a way as to provide room for wiring, air-flow and cable runs.

1.4 Wiring VertX

CAUTION: Connectors on the V1000 right and left sides are positioned as mirror images and are not interchangeable once the installation is complete. Therefore, you cannot simply unplug a connector from one side and plug it into the corresponding connector on the other side of the board.

1. **Network Connection:** Connect the V1000 to the network using a standard Cat5 network patch cable. Connect one end of the Cat5 network patch cable to the **J1** (RJ-45) connector on the V1000 and the other end to the network connection point (network jack, hub, switch, or router) on your site.

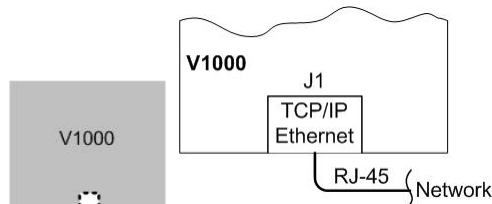

2. **Serial (RS-232) Adapter cable (P/N 70007)** – The Serial Adapter cable is included with the V1000 controller.

The Serial Adapter cable is a six inch adapter that converts the 9 pin MTA header to a standard DB-9 male connector. This adapter is to be utilized for attaching a standard RS-232 serial modem cable (not included) to the VertX controller. This will allow one of the approved external modems (listed in 1.5.1 Modem Setup Requirements, page 10) to be attached to the V1000.

The following table shows the P17 pin settings.

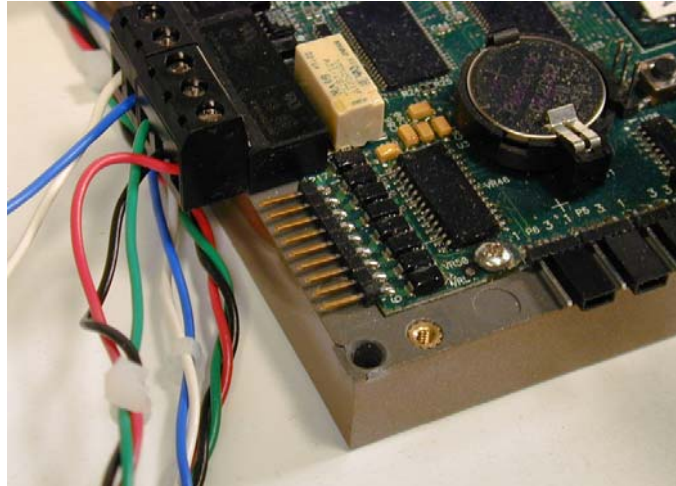
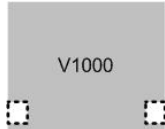

Pin #	P17
1	DCD
2	RX
3	TX
4	DTR
5	GND
6	DSR
7	RTS
8	CTS
9	RI

3. **Power and Alarm Input connections:** Connect power by providing 12VDC to the **P7** connector. +12VDC goes to **Pin 1** and ground to **Pin 2**. Bat Fail, AC Fail, and Tamper switch inputs are wired as shown in the table. Connect the Bat Fail and AC Fail inputs to the battery low/failure and AC failure contacts on the power supply. Connect the Tamper input to a tamper switch on the enclosure.

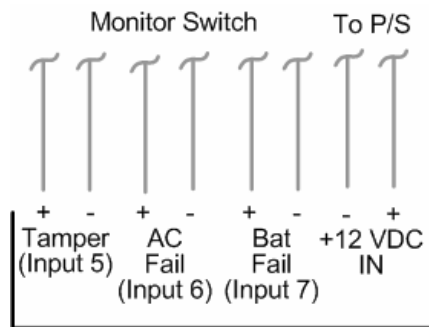

Pin #	P7
1	+12VDC
2	Ground
3	Bat Fail -
4	Bat Fail +
5	AC Fail -
6	AC Fail +
7	Tamper -
8	Tamper +

4. **RS-485 Connections** – The V1000 has two - RS-485 connectors and uses the 10-pin connector on **P3** and **P4**. Each RS-485 bus can support a maximum of 16 V100-Series panels using one or two ports.



Having two ports on each bus provides the option of splitting each RS-485 bus into two physical connections, allowing a total of four physical connections for the two busses.

RS-485 busses must be connected in a daisy chain topology and not a star topology.

The V1000 termination jumper should be in the **Out** position if there are no panels attached to that port. If there are downstream panels attached then the termination jumper should be in the **In** position.

PCB Pin #	V1000 P3 (port 1 and 2)	PCB Pin #	V1000 P4 (port 3 and 4)
1	A	1	Not in use
2	B	2	Not in use
3	Shield	3	Shield
4	Not in use	4	B
5	Not in use	5	A
6	A	6	Not in use
7	B	7	Not in use
8	Shield	8	Shield
9	Not in use	9	B
10	Not in use	10	A

CAUTION: The V1000 RS-485 Ports 1 and 2 (P1) are a common bus and therefore cannot have panels with duplicate Interface Addresses assigned. The same is true of the V1000 RS-485, Ports 3 and 4 (P4). For example, two panels, both with Interface Address 0 (factory default), cannot be connected to Ports 1 and 2 (P1).

It is recommended to wire the RS-485 to the **In** position of the P9 terminal block of the V100-Series panel. This is especially important when the RS-485 communication is in a “daisy chain” configuration. If the RS-485 is wired **In** and **Out**, and power is lost, or the P9 terminal block is unplugged on a V100-Series panel, RS-485 communications will be lost to downstream V100-Series panels.

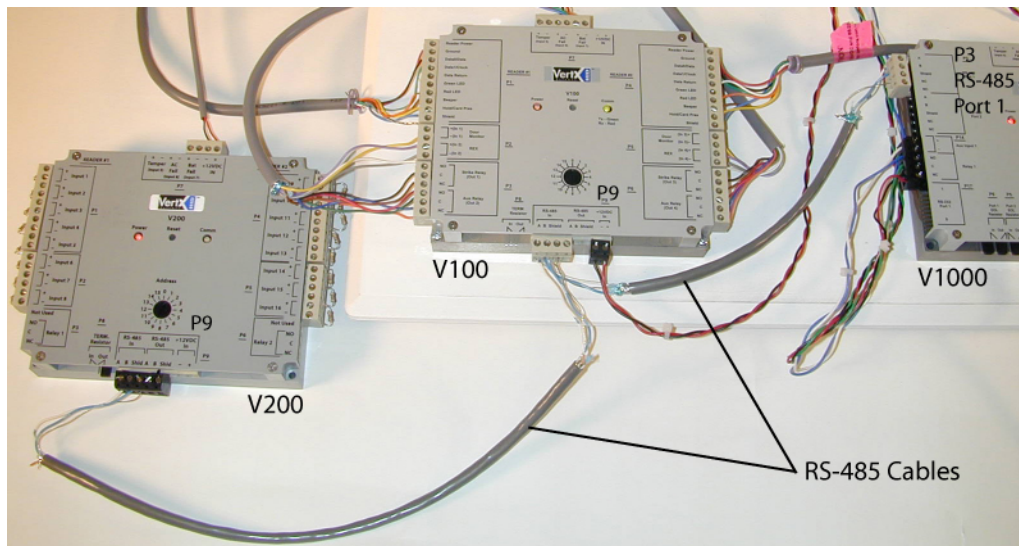

5. **Output Connections** – All Output connections are used for general purpose controls. The following table shows where the various outputs are located among the various VertX devices. Pin numbers shown use the convention “NO/C/NC”. For example, Output 1, V2000: P3 Pin1 is NO (Normally Open) and Pin 2 is C (Common) and Pin 3 is NC (Normally Closed).

Note: Relays are dry contact rated for 2Amps @ 30VDC.

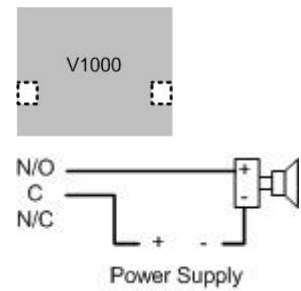

Output number	V2000	V1000	V100	V200	V300
1	P3 Pins 1/2/3 Strike(lock) Relay 1	P14 Pins 3/4/5	P3 Pins 1/2/3 Strike (lock) Relay 1	P3 Pins 2/3/4	P1 Pins 1/2/3
2	P3 Pins 4/5/6 Aux Relay 1	P11 Pins 3/4/5	P3 Pins 4/5/6 Aux Relay 1	P6 Pins 3/2/1	P1 Pins 4/5/6
3	P6 Pins 6/5/4 Strike (lock) Relay 2		P6 Pins 6/5/4 Strike (lock) Relay 2		P1 Pins 7/8/9
4	P6 Pins 3/2/1 Aux Relay 2		P6 Pins 3/2/1 Aux Relay 2		P2 Pins 1/2/3
5					P2 Pins 4/5/6
6					P2 Pins 7/8/9
7					P4 Pins 9/8/7
8					P4 Pins 6/5/4
9					P4 Pins 3/2/1
10					P5 Pins 9/8/7
11					P5 Pins 6/5/4
12					P5 Pins 3/2/1

6. **Input Connections** – Input connections are analog inputs used for a combination of specific functions such as Request-to-Exit (REX), Door monitor, etc. They can also be used as general purpose monitoring. Connect one side of the switch or contact to the + (plus) lead and the other to the – (minus) lead. The following table shows where the inputs are located among the different VertX devices. Pin numbers shown on the cover use the convention +/-.

All V1000 input points are defaulted for NO switches and are unsupervised (no EOL resistors).

Any input can be configured as NO or NC, as well as unsupervised or supervised. They can be configured for supervisory resistors of 1K – 6K Ohm. The setup of supervised inputs should be done during configuration of the VertX devices via the central station automation software (host).

Example: Input 1, V1000 is: P14 Pin1 is + and Pin 2 is -.

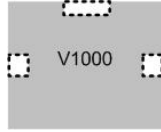

Supervised inputs can be configured for:

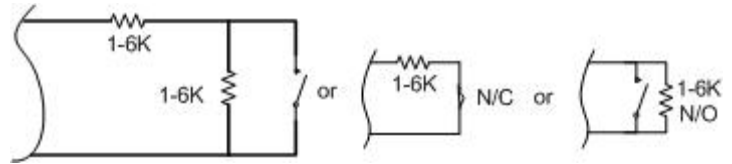

Except for door monitor, all other inputs default to NO, unsupervised:

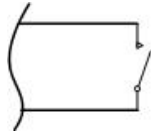

Input number	V2000	V1000	V100	V200	V300
1	P2 Pins 1/2 <i>Door Monitor</i>	P14 Pins 1/2	P2 Pins 1/2 <i>Door Monitor</i>	P1 Pins 1/2	P6 Pins 2/1
2	P2 Pins 3/4 <i>REX Input</i>	P11 Pins 4/3	P2 Pins 3/4 <i>REX Input</i>	P1 Pins 3/4	P3 Pins 1/2
3	P5 Pins 4/3 <i>Door Monitor</i>	P7 Pins 8/7 <i>Tamper</i>	P5 Pins 4/3 <i>Door Monitor</i>	P1 Pins 5/6	P7 Pins 8/7 <i>Tamper</i>
4	P5 Pins 2/1 <i>REX Input</i>	P7 Pins 6/5 <i>AC Fail</i>	P5 Pins 2/1 <i>REX Input</i>	P1 Pins 7/8	P7 Pins 6/5 <i>AC Fail</i>
5	P7 Pins 8/7 <i>Tamper</i>	P7 Pins 4/3 <i>Batt Fail</i>	P7 Pins 8/7 <i>Tamper</i>	P1 Pins 9/10	P7 Pins 4/3 <i>Batt Fail</i>
6	P7 Pins 6/5 <i>AC Fail</i>		P7 Pins 6/5 <i>AC Fail</i>	P2 Pins 1/2	
7	P7 Pins 4/3 <i>Batt Fail</i>		P7 Pins 4/3 <i>Batt Fail</i>	P2 Pins 3/4	
8				P2 Pins 5/6	
9				P4 Pins 10/9	
10				P4 Pins 8/7	
11				P4 Pins 6/5	
12				P4 Pins 4/3	
13				P4 Pins 2/1	
14				P5 Pins 6/5	
15				P5 Pins 4/3	
16				P5 Pins 2/1	
17				P7 Pins 8/7 <i>Tamper</i>	
18				P7 Pins 6/5 <i>AC Fail</i>	
19				P7 Pins 4/3 <i>Batt Fail</i>	

1.5 Modem

The VertX controller will automatically answer incoming calls when an external serial modem is attached to the RS-232 port 1.

1.5.1 Modem Setup Requirements

- External Modem (not included). The modem must be selected from the following approved HID modem list:
 - Zoom V.90 56 K Fax Modem, Model 2949 (external modem uses phone jack)
 - U.S. Robotics V.92 56K Fax Modem, Model 5686 (external modem uses phone jack)
 - Telular GSM 850/1900, Model 1C02A160 (external cellular modem)
- RS-232 Serial modem cable (not included)
- HID Serial Adapter cable (included with the VertX controller)
- AC electrical outlet or surge protector for supplying power to the modem
- Analog phone line
- VertX V1000 controller

1.5.2 Physical Modem Setup

1. Connect the RS-232 Serial modem cable (purchased separately) 9 or 25-pin connector into the back of the modem.
2. Connect the other end of the RS-232 Serial modem cable (9-pin connector) into the HID Serial Adapter cable (P/N 70007). In addition, connect the HID RS-232 Serial Adapter cable into P17 RS-232 Port 1.
3. Connect one end of the phone cord (included with the modem) into the TELCO or LINE jack on the back of the modem and plug the other end into an analog telephone wall jack.
4. Plug the power adapter (included with modem) into a surge protector or electrical outlet. Make sure you use the power adapter that came with the modem, as others may be of different voltages and could damage your modem.
5. Turn on the modem. This is usually done by using a switch located next to the status lights. There may also be a power switch located on the back of the modem.

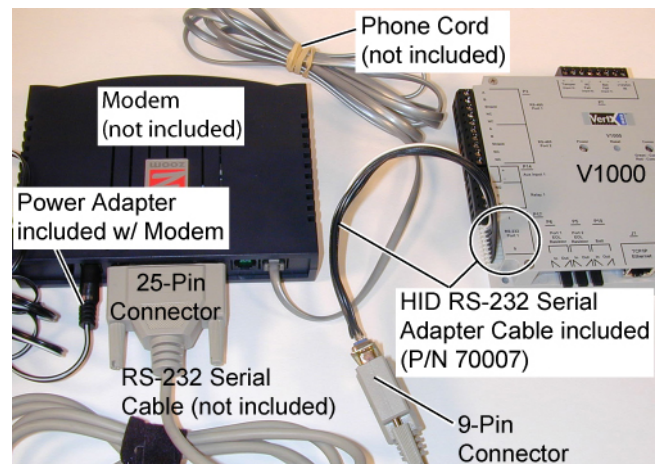

Step 2 Contact

Contact the VertX controller through two methods.

- Discovery Client (DHCP or Static TCP/IP Configurations Only)
- Virtual Port

2.1 Discovery Client

The Discovery Client provides a technician with a method of locating all of the VertX controllers that are connected to a network. Controller information is displayed providing the ability to 'blink' the VertX controller Comm LED and configure the unit by launching a browser pointed at the Configuration GUI of the targeted controller. When the Discovery Client is launched, a discover command is issued and the Configuration GUI screen is populated with the results. Also provided is the ability to refresh the Configuration GUI screen on command.

Use this feature when the VertX controllers and network have been installed and are operational, but before the VertX controller(s) has been configured. At this point, all of the controllers on a network will have the same host name and unknown IP addresses (assuming a DHCP environment). In this scenario, the only mechanism available to configure a controller is the serial debug port or by only placing one controller on the network at a time. The Discovery Client provides an easy to use mechanism to configure controllers.

2.1.1 Installation

An operating system of Windows® XP with .NET Framework v2.0 installed is a requirement for the Discovery Client to function properly.

1. The Discovery Client can be downloaded by placing the following path in an Internet browser.
<http://www.hidcorp.com/downloads/DiscoveryClient.zip>
2. The **File Download** dialog will display, click **Open**
3. When the contents of the zip file display, double-click **setup.exe**
4. If a security warning is received, click **Run**
5. From the Discovery Client Welcome page, click **Next**
6. Select the Installation folder and who should have access to the Discovery Client, click **Next**
7. Confirm the installation location, click **Next**
8. Click **Close**

2.1.2 Use

The following provides information on how to access and use the Discovery Client.

1. Enable VertX controllers on the network
2. Click **Start > Programs > VertX Tool Box > Discovery GUI** to access the Discovery Client
3. Returned is a list of controllers attached to the network. If there is more than one controller listed, controllers can be identified using the MAC Address label on the unit
4. If unsure of a controllers physical location click **Blink ON** to start the Comm LED blinking on the controller. Note the name on the button will change to **Blink OFF**. When verification of the controller is complete, click **Blink OFF**
5. Click **Configure Unit** to open the **Basic Configuration** page of that controller
6. Go to Step 3 Configure, page 12

2.2 Virtual Port

Contact a VertX controller by directly connecting the computer to the controller using an Ethernet cable. By default, every controller is configured to respond to a fixed address: **169.254.242.121**.

1. Ensure you are running a Windows 2000 or XP computer
2. Disconnect your Windows computer from its hub or network
3. Connect the Windows computer to the controller with an Ethernet cable
4. Using the Windows™ **Start** button, click **Start > Run**
5. Enter **ipconfig /renew** -- wait for DHCP to timeout (approximately 60 sec). The computer will acquire a **169.254.x.x** address
6. Access a web browser and enter **169.254.242.121** into the **Address** field. The controller is now accessible through this Virtual Port

Step 3 Configure

This section describes the communications configuration that enables the controller to communicate with the central station host automation software.

There are three methods of communication possible on a V1000 controller:

- Dynamic Host Configuration Protocol (DHCP) TCP/IP Addressing
- Static TCP/IP Addressing (see [Configuration Checklist](#), page 18 for a list of criterion needed for a Static TCP/IP configuration)
- Modem (see [Configuration Checklist](#), page 18 for a list of criterion needed for a modem configuration)

Enter only the configuration that relates to your sites specific installation.

Note: Review the [central station automation software](#), page 16 for requirements before continuing.

3.1 VertX Communications

The VertX communications configuration is provided through a browser-based application called the **Configuration GUI** (Graphic User Interface).

3.1.1 Configuration GUI Login

The **Login** screen for that controller will display.

In the **User name** field, enter **admin** (leaving the **Password** field empty). Click **OK**.

3.1.2 Basic Network Setup

Select the **Connection Selection** radio button to establish your systems specific communication type.

Choices include:

- Network
- Modem
- Network with Modem Backup

Default network information will load. Before making changes, review the default network information.

Note: Most configurations will **not** require accessing the **Advanced Setup** screen.

3.1.2.1 Static Network

If using a Static TCP/IP network, proceed with changes using the information collected on the [Configuration Checklist](#), page 18.

3.1.2.2 DHCP Network

If using a DHCP TCP/IP network, this information is configured automatically.

3.1.2.3 Modem

If using a Modem, proceed with changes using the information collected on the [Configuration Checklist](#).

3.1.3 Basic Central Station / Host Communication Setup

Enter the **CS/Host IP Address** or **Host Name**, and the **Here I Am Interval** collected on the [Configuration Checklist](#), page 18. See [central station automation software](#), page 16.

3.1.3.1 Controller Login Password

During your first instance of accessing the Configuration GUI, you must change the password (located at the bottom of the screen). Enter a new password, and reenter the password in the second field.

Note: This step is not necessary during any consecutive Configuration GUI sessions. However on consecutive sessions the password may be changed.

Once configuration changes have been made, click **Submit**, and the **Confirmation** page (see 3.1.4 Confirmation, page 13) will display.

3.1.4 Confirmation

Once configuration changes are complete and submitted, the **Confirmation** screen will display. Verify that the changes submitted are accurate, and click **Save**. If the changes submitted are not accurate, click **Cancel** and adjust the settings appropriately.



The basic setup entries are listed below.

The parameters that were changed appear as shown in this text.

Connection Selection

Connection Type: Network

Basic Network Setup

VertX Addressing: Static

IP Address: **10.7.6.134**

Subnet Mask: 255.0.0.0

Default Gateway: 10.7.0.1

Primary DNS Server: **10.7.2.220**

Secondary DNS Server: **10.7.2.221**

Basic Central Station/Host Communications Setup

CS/Host IP Address: 10.19.4.130

Here I Am Interval (sec): **60**

Select Save to confirm the network settings and the VertX controller will be configured as listed above, or select Cancel to reconfigure.



Step 4 Communicate

Now that the V1000 is connected, contacted and configured, contact the Central Station to test the system.

Basic setup is now complete!

Additional trouble-shooting tools are available on the [System Status](#) and [Supplemental Configuration](#) (page 14) screens.

Appendices

Trouble-shooting

System Status

System Status provides a technician with a method of validating the VertX installation, field wiring and installed devices. Perform the System Status at any time after the VertX controller has been installed and power is available. In addition, a technician may perform a system status as many times as necessary.

Upon startup, the **System Status** page will discover all connected and powered V100-Series devices attached to the controller and displays the inputs, outputs, and host status.

Reference the **Legend** to determine the meaning of the different images.

By clicking **Add Unconfigured** you can configure the V1000 for the attached panels and readers. The assumption is that two readers are attached to any V100 interface panel and that both readers are Wiegand card only. Once the configuration is complete, the VertX software will refresh.

Once the page refreshes, a **Restore Previous** button becomes available.

The **Restore Previous** button enables the technician to use the previously saved configuration.

Supplemental Configuration

Supplemental Configuration provides the ability to view and configure system inputs and outputs

These buttons provide navigation to the following functionality:



Configure - configure inputs, outputs and door characteristics for a V1000, V100, V200, and V300



System Time - update System Time



Update System – updates the interface boards firmware

Configure

Configure provides the ability to view and modify system inputs and outputs and door characteristics.

Upon successful validation, the **Save** button will write modified values to the interface board.

System Time

System Time provides the ability to view and set the date, time, and time zone values on the controller.

Upon initialization, Date, Time, Time Zone and TZ fields will be populated with the current system settings. The date displayed (non-text box) will be updated approximately every 30 seconds.

date displayed (non-text box) will be updated approximately every 30 seconds.

The **Time Zone** field provides a drop-down menu. One of the options in the **Time Zone** drop-down menu is **Custom Time Zone**. If **Custom Time Zone** is selected, the **TZ** text box will be enabled. Otherwise, the TZ is associated with the **Time Zone** field.

Update System

Update System allows the user to update the firmware on the interface board. During a download the interface board image flashes between grey and yellow. When a download completes the image color changes to green for successful or red for failure. If the download fails, a tool tip with the error status code may be viewed by hovering the mouse over the image in question.

Initially, all of the interface boards will be selected for a download to commence.

Note: Depending on the VertX controller and system, it may take several minutes to completely download.

Network Defaults Jumper

The **Network Defaults Jumper** requires that someone with physical access to the V1000, place a jumper over the debug port prior to the controller rebooting. The controller reconfigures its network settings to the factory defaults when the jumper is on the debug port during a reboot. From this point, configuration (or re-configuration) will proceed normally.

Use the Network Defaults Jumper to correct potential errors in a VertX controllers network configuration.

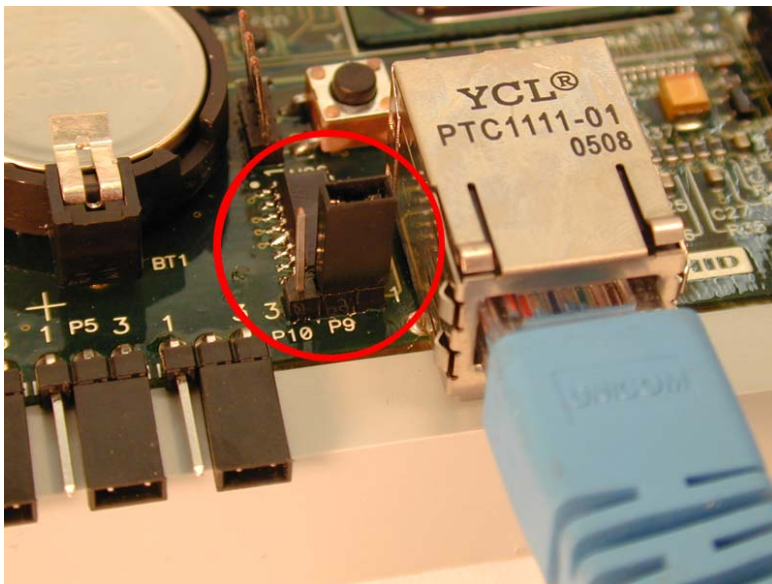

1. Place a jumper over the right two pins of the P9 debug port.
2. Reboot the controller to change **all** of the network configuration settings back to the factory defaults.
3. After the LED turns amber, remove the jumper from the P9 debug port. Upon removing the jumper it takes approximately 60 seconds for the controller to reset. Once the reset is complete, the LED will return to green.

CAUTION: During the process of rebooting the controller, all network configuration information will be overwritten and returned to the original defaults.

4. Configure the controller for your installation parameters. See 3.1 VertX Communications, page 12.

Firewall

If the VertX controller is being installed where it communicates through a firewall, then the firewall may need to be configured to allow TCP data transfer on the specified port(s).

1. Before starting, ensure that any pop-up blocker software is disabled on the computer.
2. Open the following ports on the firewall.
 - **connection_port (4070)** TCP outbound. This port must be open on the Host computer.
 - **listen_port (4050)** TCP incoming. This port must be open when using selected applications. See the Central Station for information.

If you are **not** familiar with configuring a firewall for a network, contact the Network/IT administrator or manager.

CAUTION: If the firewall is not configured properly the controller may not communicate with the host.

Central Station Automation Providers

Central Station Automation Software	Here I am Interval
Dice Corporation	60
Bold Technologies	60
Micro Key Software	3600
Patriot Systems	Pending

Perform the following steps if the central station requires the **Here I am Interval** to change.

1. Open your Internet Browser.
2. Enter the V1000 IP address or host name into the **Address** field.
3. Click  **Go**.
4. Change the **Here I am Interval** from **0** (default) to the new parameter.
5. Click **Submit** and the change will become activated once the controller is rebooted.
6. Close the browser window(s) when completed.

Contact Information

Americas

HID Global (California, USA)
support: support_na@hidvertx.com
sales: sales@hidvertx.com
main: (949) 598-1600
sales: (800) 210-4744
telephone: 1-800-237-7769
fax number: (949) 598-1690

Europe, Middle East and Africa

HID Corporation, Ltd. (Haverhill, UK)
support: support_emea@hidvertx.com
sales: salesemea@hidvertx.com
telephone: +44 1440 714 850
fax number: +44 1440 714 840

Asia-Pacific

HID Asia Pacific Ltd. (Hong Kong)
support: support_APAC@hidvertx.com
sales: salesapac@hidvertx.com
telephone: (852) 3160 9802
fax number: (852) 3160 4809

All National and local Electrical codes apply.

- **This equipment is intended to be powered from a limited power source output of a previously certified power supply.**
- **Changes or modifications not expressly approved by the party responsible for compliance could void the user's authority to operate the equipment.**

Class A Digital Devices

FCC Compliance Statement: This equipment has been tested and found to comply with the limits for a Class A digital device, pursuant to part 15 of the FCC Rules. These limits are designed to provide reasonable protection against harmful interference when the equipment is operated in a commercial environment. This equipment generates, uses, and can radiate radio frequency energy and, if not installed and used in accordance with the instruction manual, may cause harmful interference to radio communications. Operation of this equipment in a residential area is likely to cause harmful interference in which case the user will be required to correct the interference at his own expense.

Class B Digital Devices

FCC Compliance Statement: This equipment has been tested and found to comply with the limits for a Class B digital device, pursuant to the limits for a Class B digital device, pursuant to part 15 of the FCC Rules. These limits are designed to provide reasonable protection against harmful interference in a residential installation. This equipment generates, uses, and can radiate radio frequency energy and, if not installed and used in accordance with the instructions, may cause harmful interference to radio communications. However, there is no guarantee that interference will not occur in a particular installation. If this equipment does cause harmful interference to radio or television reception, which can be determined by turning the equipment off and on, the user is encouraged to try to correct the interference by one or more of the following measures:

- Reorient or relocate the receiving antenna.
- Increase the separation between the equipment and the receiver.
- Connect the equipment into an outlet on a circuit different from that to which the receiver is connected.
- Consult the dealer or an experienced radio/TV technician for help.

